



Implementation of a LiFePO₄ battery charger for cell balancing application

Amin*, Kristian Ismail, Abdul Hapid

Research Centre for Electrical Power and Mechatronics, Indonesian Institute of Sciences
Jl. Sangkuriang 21, Building 20, 2nd Floor, Bandung, West Java 40135, Indonesia

Received 14 May 2018; received in revised form 26 November 2018; accepted 28 November 2018
Published online 30 December 2018

Abstract

Cell imbalance always happens in the series-connected battery. Series-connected battery needs to be balanced to maintain capacity and maximize the batteries lifespan. Cell balancing helps to distribute energy equally among battery cells. For active cell balancing, the use of a DC-DC converter module for cell balancing is quite common to achieve high efficiency, reliability, and high power density converter. This paper describes the implementation of a LiFePO₄ battery charger based on the DC-DC converter module used for cell balancing application. A constant current-constant voltage (CC-CV) controller for the charger, which is a general charging method applied to the LiFePO₄ battery, is presented for preventing overcharging when considering the nonlinear property of a LiFePO₄ battery. The prototype is made up with an input voltage of 43 V to 110 V and the maximum output voltage of 3.75 V, allowing to charge a LiFePO₄ battery cell and balancing the battery pack with many cells from 15 to 30 cells. The goal is to have a LiFePO₄ battery charger with an approximate power of 40 W and the maximum output current of 10 A. Experimental results on a 160 AH LiFePO₄ battery for some state of charge (SoC) shows that the maximum battery voltage has been limited at 3.77 V, and maximum charging current could reach up to 10.64 A. The results show that the charger can maintain battery voltage at the maximum reference voltage and avoid the LiFePO₄ battery from overcharging.

©2018 Research Centre for Electrical Power and Mechatronics - Indonesian Institute of Sciences. This is an open access article under the CC BY-NC-SA license (<https://creativecommons.org/licenses/by-nc-sa/4.0/>).

Keywords: cell balancing; constant current-constant voltage (CC-CV); DC-DC converter module; LiFePO₄ battery.

I. Introduction

Recently, Li-ion batteries have been widely used in different applications, such as portable electronic devices and electric vehicles, due to their several advantages of high energy density, low self-discharge, long life cycles, and no memory effect [1][2]. The life cycles of Li-ion batteries are affected by undercharging or overcharge condition. It is because overcharge would damage the physical component of the batteries, and undercharge could reduce the energy capacity of the batteries.

In electric vehicle application which requires high power and energy, the LiFePO₄ traction battery needs to be connected in series or series-parallel in order to increase its energy potential. This traction battery is the most critical part of an electric vehicle because it affects

the driving range, and also the battery types mainly influence the cost of the vehicle. Since the internal impedance of each battery is not identical, a series-connected battery needs to be balanced to maintain their capacity. It becomes more difficult to charge when the batteries are configured in a series. The battery pack tends to imbalance after consecutive charge/discharge process [3].

Cell imbalance always occurs in the series-connected battery which leads in the degradation of an individual cell. Furthermore, the capacity of the battery pack will be reduced quickly and shorten the batteries lifespan. A battery management system (BMS) to observe LiFePO₄ batteries is crucial for safety and operational reasons. It avoids cell breakdowns caused by undercharging or overcharging, keeps the balance of the voltage among battery cells, each cell in safe operating condition, and monitors the battery temperature [4][5]. One of the most crucial features of a BMS is cell balancing. Cell balancing helps to dispart energy equally among battery cells.

* Corresponding Author. Tel: +62 823 1721 1215
E-mail address: amin_hwi@yahoo.co.id; amin@lipi.go.id

Passive and active cell balancing are two types of cell balancing method. The major distinction between both methods is that passive cell balancing removing the extra energy of the most charged cell through the passive element (resistor) and the active cell balancing is transferring the energy of the strong cell to the weak cell. Active cell balancing methods work to reduce the high energy losses observed in passive cell balancing methods. According to the active element used for storing the energy, active cell balancing has various topologies namely capacitor based, inductive based, and converters based [6]. For converter based active cell balancing, the DC-DC converter module is commonly used to achieve high efficiency, reliability, and high power density converter. This DC-DC converter module is used to charge every LiFePO₄ battery in the battery pack to balance the battery pack. In other words, the DC-DC converter module acts like a LiFePO₄ battery charger. In [6], DC-DC converter modules were used for balancing among battery modules through the auxiliary battery with maximum current rating of 6 A. A method using a single equalizer circuit that can be switched to a target cell via a set of sealed relays was proposed in [7] and [8] for balancing battery cells. In this method, a DC-DC converter module was used for cell balancing with a maximum current rating from 4 to 5 A. In [9] and [10], a DC-DC converter module was used for balancing the selected weak cell via a matrix of electronic relays with a balance current close to 6 A.

The previous studies explained that the DC-DC converter module could charge or balance the battery with a maximum current rating of 6 A. In this work, the DC-DC converter module was designed to charge or balance LiFePO₄ battery with maximum current rating of 10 A. This bigger current rating is used to achieve faster balancing time in the electric vehicle battery.

This study discusses the implementation of a LiFePO₄ battery charger for cell balancing application with a maximum current rating of 10 A. To obtain a clear and comprehensive analysis of the effect of 10 A of current rating, the components value of the LiFePO₄ battery charger circuit was calculated and followed by efficiency calculation. In order to validate the charger circuit, the charger prototype was build and followed by an experimental test. The detailed analysis of the voltage and current characteristics of the LiFePO₄ battery with the different initial state of charge are discussed as the focus of this study.

II. Materials and methods

In LiFePO₄ batteries applications, a battery system contains the battery and battery management system (BMS). One important requirement for LiFePO₄ BMS is to observe the voltage across each cell when more than one cell is connected in series to assure charge equalization and voltage balancing of the cells. A protection circuit is usually added to the charger circuit to manage cells voltage. LiFePO₄ batteries have very crucial charging requirements that must be fulfilled during charging to assure safe operating condition. Battery charging plays an important role in the BMS,

where the charging method has a strong effect on battery performance and life cycles.

A charger has three main functions: supplying charge to the battery; optimizing the charge rate; and stopping the charge [1]. The charge can be supplied to the battery through a different charging method, depending on the battery chemistry. For LiFePO₄ batteries, a constant current-constant voltage (CC-CV) charging method is very popular and commonly used in charging LiFePO₄ batteries because of implementation easiness and simplicity [1][11][12]. In this paper, a constant current-constant voltage (CC-CV) method was used for preventing overcharging of the LiFePO₄ battery.

This CC-CV method also the most widely adopted charging method to develop a charger for a Li-ion battery with some improvement methods. In [2] and [13], Li-ion battery internal resistance compensation is used in CC-CV based charger. Not only for low power Li-ion charger, but the CC-CV method was also used for high power Li-ion battery charger [14]. Other improvement methods for CC-CV based charger are using on-off duty cycle control zero computational algorithms [15], and inductive power transmission with temperature protection [16]. The CC-CV based charger was also used in different charger topology, they are LLC resonant converter [17] and PFC Sheppard Taylor converter [18].

LiFePO₄ batteries require a constant current (CC) to charge the battery until the battery voltage achieves a predefined safety limit (maximum charging voltage) at which a constant voltage (CV) begins. Then, the charging voltage is kept at a maximum charging voltage, while simultaneously, the charging current is exponentially reduced as shown in Figure 1. A constant voltage (CV) charging is used to limit the current and thus prevent the battery from overcharge. The charging process ends when the charging current achieves a small preset current. The charging curve of the CC-CV charging method is shown in Figure 1 [11].

A. LiFePO₄ battery charger circuit

The DC-DC converter module is voltage regulating device and makes it feasible to utilize them as efficient high-power current sources because of their wide trim range. Current regulation of the DC-DC converter can be performed through a current-sense resistor and the addition of an external control loop. The isolated DC-DC converter module circuit that is used as a LiFePO₄ battery charger is shown in Figure 2 [19].

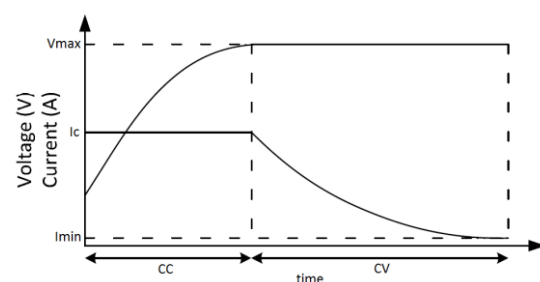

Figure 1. Charging curve of the CC-CV method

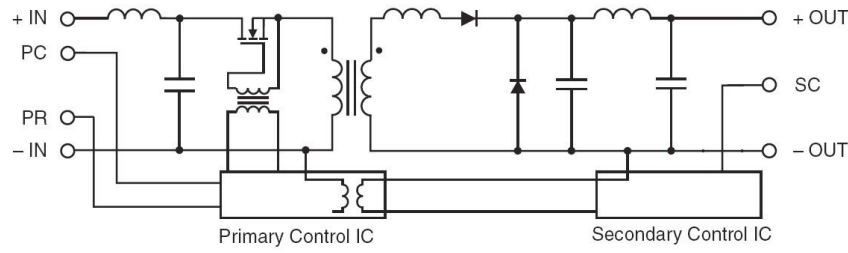
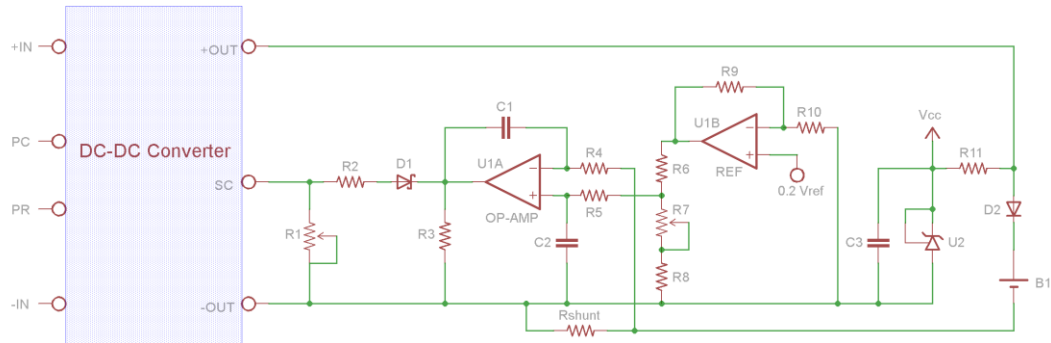

Figure 2. DC-DC converter module circuit

Figure 3. LiFePO₄ battery charger circuit

From Figure 2, the output voltage of the DC-DC converter can be adjusted by controlling the SC pin. In order to meet the low-cost requirement, an analog circuit was used to control the DC-DC converter module. Figure 3 shows the detail of the LiFePO₄ battery charger circuit based on an analog circuit [20].

The LiFePO₄ battery charger was created based on isolated DC-DC converter module with an input voltage of 43 V to 110 V, allowing to charge a LiFePO₄ battery cell and balancing the battery pack with many cells from 15 to 30 cells. Thus, a LiFePO₄ battery charger with an approximate power of 40 W, and with a maximum output current (I_{max}) of 10 A was obtained. Table 1 summarizes the charger specifications.

Considering a LiFePO₄ battery with a nominal voltage of 3.2 V, the selected float voltage (V_{float}) is 3.75 V. The required maximum output voltage of the DC-DC converter module (V_{max}) is given as:

$$V_{max} = V_{float} + V_F = 3.75 + 0.3 = 4.05V \quad (1)$$

where V_F is a voltage drop on the Schottky protection rectifier D2.

According to [20], the components value of the LiFePO₄ battery charger were calculated and summarized in Table 2.

Table 1. Charger specifications

Parameters	Values
Input voltage	43 to 110 V
Output voltage	4.05 V
No. li-ion cells	15-30 cells
Max output current	10 A
Max power	40 W

B. LiFePO₄ battery charger efficiency

Based on LiFePO₄ battery charger circuit as shown in Figure 3, the components with significant power dissipation in this charger system are the DC-DC converter module, the shunt resistor (P_{Rshunt}), and the Schottky diode (P_{D2}). In this derivation of an estimate of LiFePO₄ battery charger efficiency, other sources of power dissipation will be neglected.

At the end of the constant current (CC) phase, the output power to the battery (P_{OUT}) will be:

$$P_{OUT} = V_{max} \cdot I_{max} = 4.05 \cdot 10 = 40.5W \quad (2)$$

Table 2. Components value of the LiFePO₄ battery charger

Component	Value
R1	10 k Ω
R2	357 Ω
R3	47 k Ω
R4	4.7 k Ω
R5	14.7 k Ω
R6	20 k Ω
R7	100 k Ω
R8	20 k Ω
R9	20 k Ω
R10	20 k Ω
R11	22 Ω
Rshunt	12.5 m Ω
C1	470 nF
C2	680 nF
C3	470 pF
D1	BAT85
D2	MBR1545
U1	LM10
U2	TL431

The power dissipated on the Schottky diode D2 (P_{D2}) and the shunt resistor (P_{Rshunt}) can be calculated using Equation (3) and (4).

$$P_{D2} = V_F \cdot I_{\max} = 0.3 \cdot 10 = 3W \quad (3)$$

$$P_{Rshunt} = I_{\max}^2 \cdot R_{shunt} = 10^2 \cdot 0.0125 = 1.25W \quad (4)$$

Therefore, the output power from the DC-DC converter module (P_{TOT}) is:

$$\begin{aligned} P_{TOT} &= P_{OUT} + P_{D2} + P_{Rshunt} \\ &= 40.5 + 3 + 1.25 = 44.75W \end{aligned} \quad (5)$$

Considering a worst-case efficiency of 81.3% for the DC-DC converter module [21], the input power of the DC-DC converter module (P_{IN}) will be:

$$P_{IN} = \frac{P_{TOT}}{\text{Efficiency}} = \frac{44.75}{0.813} = 55.043W \quad (6)$$

The overall efficiency of the LiFePO₄ battery charger (Eff_{TOT}) is:

$$Eff_{TOT} = \frac{P_{OUT}}{P_{IN}} = \frac{40.5}{55.043} = 0.7358 = 73.58\% \quad (7)$$

III. Results and discussions

A. Charger prototype

According to the LiFePO₄ battery charger specification described in section II, the circuit will be implemented using Vicor Power V72C5E100BL DC-DC converter module. A LiFePO₄ battery charger prototype has been implemented to validate the effectiveness of the charger design. The prototype of the LiFePO₄ battery charger is shown in Figure 4 and experimental test for charge a LiFePO₄ battery has been carried out as shown in Figure 5.

From Figure 4, the core of the charger circuit is an LM10 (U1) operational amplifier and voltage reference. A shunt regulator (U2) is adjusted to supply a voltage of 2.5 V from the output of the DC-DC converter module to the LM10. The op-amp (U1A) acts as an

error amplifier and is designed as an integrator using capacitor C1 and resistor R4. Resistor R9 and R10 are used to set the internal reference voltage at the non-inverting op-amp input. Subsequently, the reference voltage is compared with the current-sense resistor (R_{shunt}) voltage to control the load current. The op-amp (U1A) activates the Schottky diode (D1) cathode to adjust the DC-DC converter module output. An initial condition when a voltage is off can be done by fully discharging the voltage across capacitor C1 using resistor R3. The diode D1 with a low forward voltage increased the output voltage of the DC-DC converter module and used to avoid the op-amp (U1A) from overdriving the SC pin. The resistor R1 adjust the float voltage by decreasing the converter maximum output voltage. The battery voltage (B1) rise to a constant float voltage as the increases of battery state of charge. The diode D2 connected series to the positive terminal of the battery to isolate the output of the DC-DC converter module in case of malfunction and avoid the battery activates the circuit when the charger is off.

B. Experimental test

Figure 5 shows the experimental apparatus to test the charger prototype. It consists of a power supply unit as an input of the charger. This power supply unit is used to replace the voltage of the battery pack in the battery management system with a number of the cell from 15 to 30 cells. A current sensor based on ACS712 was used to measure the current to the 160AH LiFePO₄ battery. The charge current and voltage of the LiFePO₄ battery was stored using LGR-5327 Datalogger to know the behavior and effectiveness of the charger.

C. Testing result

The LiFePO₄ battery charger was used to charge a 160AH LiFePO₄ battery with a different initial voltage that represents a different state of charge (SoC) to test the CC-CV charging method and simulate the battery balancing system. Figure 6, Figure 7, and Figure 8 present cell voltage and charging current for some charging process with different initial voltage. Experimental results show that at the beginning of the



Figure 4. LiFePO₄ battery charger prototype



Figure 5. Experimental test

charging process, the LiFePO₄ battery was charged with certain current and decrease slowly. At the end of the charging process (CV stage), the LiFePO₄ battery voltage was kept at the maximum reference voltage and avoid the battery from overcharging.

In Figure 6, the initial voltage of the LiFePO₄ battery was 2.8 V. At the beginning of the charging process, the charge current was 10.64 A. The charge current was decreased slowly, and at the time of 27

hours, the charge current was 0.78 A, and the LiFePO₄ battery voltage was 3.64 V. At the end of the charging process, the LiFePO₄ battery voltage was maintained at 3.77 V.

In Figure 7, the starting voltage of the LiFePO₄ battery was 3.27 V. In the start of the charging process, the charge current was 7.54 A. The charge current was also decreased slowly, and at the time of 21 hours, the charge current was only 0.42 A and the LiFePO₄ battery

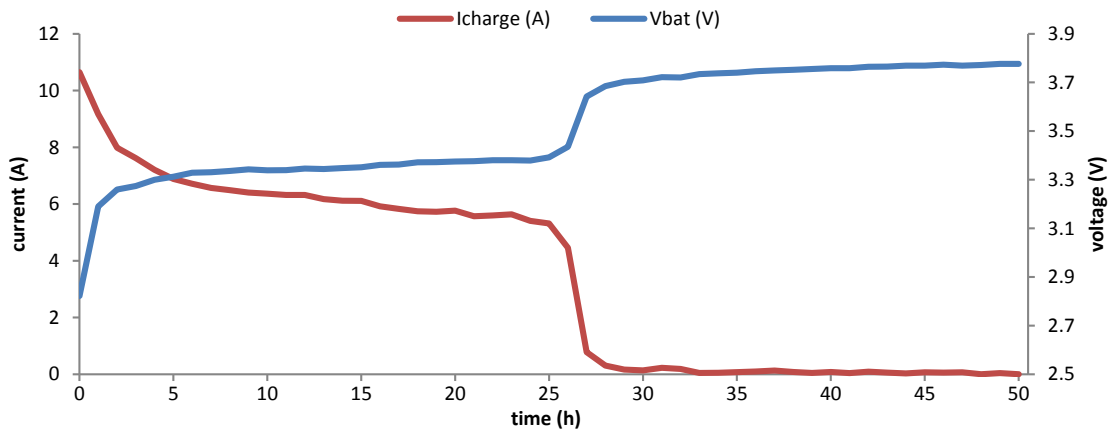

Figure 6. Charging process with initial voltage of 2.8 V

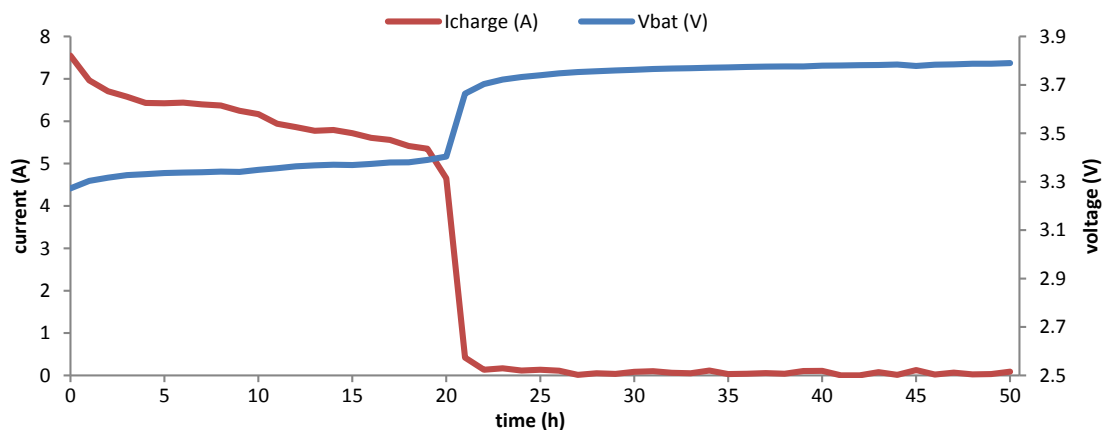

Figure 7. Charging process with initial voltage of 3.27 V

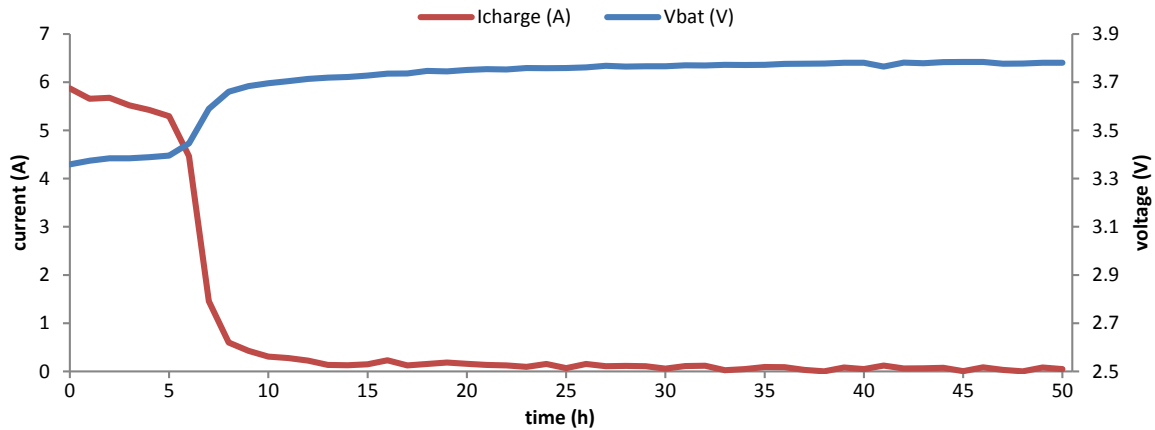

Figure 8. Charging process with initial voltage of 3.36 V

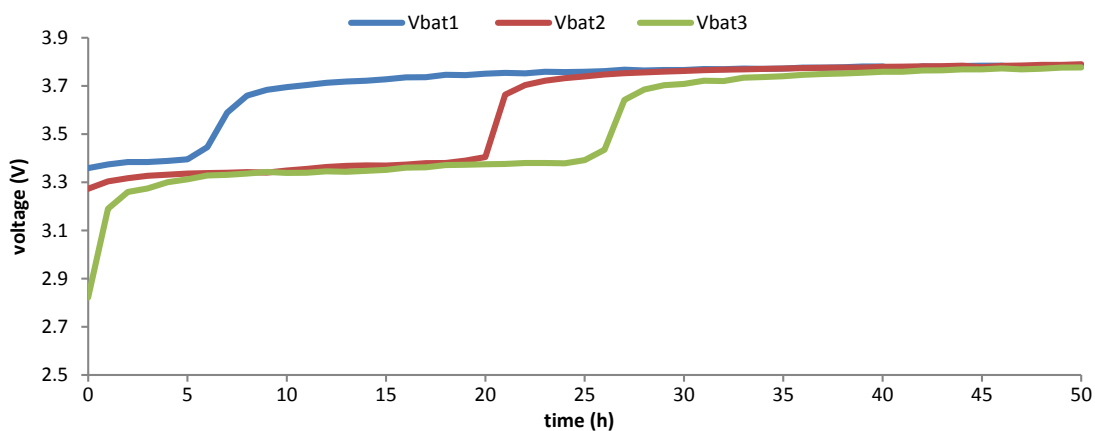

Figure 9. Charging process with different initial voltage

voltage was 3.66 V. At the end of the charging process, the LiFePO₄ battery voltage was maintained at approximately 3.78 V.

In Figure 8, the initial voltage of the LiFePO₄ battery was higher than the previous two experiments, which was 3.36 V. At the beginning of the charging, the charge current was 5.87 A. The charge current was dropped slowly and at the time of 8 hours, the charge current was only 0.6 A and the LiFePO₄ battery voltage was 3.66 V. At the end of the charging process, the LiFePO₄ battery voltage was maintained at 3.78 V.

Figure 9 shows the LiFePO₄ battery voltage for various charging process with different initial voltage to simulate cell balancing. The experimental result shows that the LiFePO₄ batteries voltage can be balanced at 3.77 V at the end of the charging process and avoid the LiFePO₄ batteries from overcharging.

In this experimental results, the DC-DC converter module was able to charge the LiFePO₄ battery with a maximum current rating of 10.64 A. The charge current is bigger than previous papers which only can charge the battery with a maximum current rating of 6 A. This bigger current rating is used to achieve faster balancing time in the electric vehicle battery.

D. Constraints and future works

In this paper, the LiFePO₄ battery charger was used especially for battery balancing in the battery

management system. Further works could be focused on verifying the effectiveness of the charger equipment. The charger will need to be tested on the battery management system to balance the battery pack with a larger number of installed cells. The cells could be varied from 15 to 30 cells.

IV. Conclusion

A 40 W LiFePO₄ battery charger was successfully designed based on DC-DC converter modules. The charger was used to charge LiFePO₄ battery cell and made up with an input voltage of 43 V to 110 V. Experimental results on a 160 AH LiFePO₄ battery for some state of charge shows that the maximum battery voltage has been limited at 3.77 to 3.78 V, and the maximum charging current could reach up to 10.64 A. This result shows that the maximum battery voltage is well regulated and the LiFePO₄ battery charger can keep the LiFePO₄ battery voltage according to the maximum reference voltage. This result shows that the charger can regulate the maximum battery voltage. It can be concluded that the charger can be used to charge a LiFePO₄ battery cell and balance the battery pack with a number of cells from 15 to 30 cells depending on the input voltage.

Acknowledgement

The Authors would like to thank all members of the Electric Vehicle research group, Research Centre for Electrical Power and Mechatronics which have already supported the battery management system research and development.

References

- [1] A. Al-Haj Hussein and I. Batarseh, "A review of charging algorithms for nickel and lithium battery chargers," *IEEE Transactions on Vehicular Technology*, vol. 60, no. 3, pp. 830–838, 2011.
- [2] L. R. Dung, C. E. Chen, and H. F. Yuan, "A robust, intelligent CC-CV fast charger for aging lithium batteries," in *Proceeding of 2016 IEEE 25th International Symposium on Industrial Electronics (ISIE)*, 2016, pp. 268–273.
- [3] Amin, K. Ismail, A. Nugroho, and S. Kaleg, "Passive balancing battery management system using MOSFET internal resistance as balancing resistor," in *Proceeding of 2017 International Conference on Sustainable Energy Engineering and Application (ICSEEA)*, 2017, pp. 151–155.
- [4] M. Brandl, H. Gall, M. Wenger, V. Lorentz, M. Giegerich, F. Baronti, G. Fantechi, L. Fanucci, R. Roncella, R. Saletti, S. Saponara, A. Thaler, M. Cifrain, and W. Prochazka, "Batteries and battery management systems for electric vehicles," in *Proceeding of 2012 Design, Automation & Test in Europe Conference & Exhibition (DATE)*, 2012, pp. 971–976.
- [5] M. N. Ramadan, B. A. Pramana, S. A. Widayat, L. K. Amifia, A. Cahyadi, and O. Wahyunggoro, "Comparative Study Between Internal Ohmic Resistance and Capacity for Battery State of Health Estimation," *Journal of Mechatronics, Electrical Power, and Vehicular Technology*, vol. 6, no. 2, p. 113, Dec. 2015.
- [6] M. Daowd, M. Antoine, N. Omar, P. Lataire, P. Van Den Bossche, and J. Van Mierlo, "Battery management system-balancing modularization based on a single switched capacitor and bi-directional DC/DC converter with the auxiliary battery," *Energies*, vol. 7, no. 5, pp. 2897–2937, 2014.
- [7] T. A. Stuart and W. Zhu, "Fast Equalization for Large Lithium Ion Batteries," *IEEE Aerospace and Electronic Systems Magazine*, vol. 24, no. 7, pp. 27–31, July 2009.
- [8] T. A. Stuart and W. Zhu, "Modularized battery management for large lithium ion cells," *Journal of Power Sources*, vol. 196, no. 1, pp. 458–464, 2011.
- [9] J.-C. Lin, "Development of a two-staged balancing scheme for charging lithium iron cells in series," *IET Electr. Syst. Transp.*, vol. 6, no. 3, pp. 145–152, 2016.
- [10] J. C. M. Lin, "Development of a new battery management system with an independent balance module for electrical motorcycles," *Energies*, vol. 10, no. 9, 2017.
- [11] W. Shen, T. T. Vo, and A. Kapoor, "Charging algorithms of lithium-ion batteries: An overview," in *Proceeding of 2012 7th IEEE Conference on Industrial Electronics and Applications (ICIEA)*, 2012, pp. 1567–1572.
- [12] B. Tar and A. Fayed, "An overview of the fundamentals of battery chargers," in *Proceeding of 2016 IEEE 59th International Midwest Symposium on Circuits and Systems (MWSCAS)*, October 2017, pp. 16–19.
- [13] C.-H. Lin, C.-L. Chen, Y.-H. Lee, S.-J. Wang, C.-Y. Hsieh, H.-W. Huang, and K.-H. Chen, "Fast charging technique for Li-Ion battery charger," in *Proceeding of 2008 15th IEEE International Conference on Electronics, Circuits and Systems*, 2008, pp. 618–621.
- [14] A. Kuperman, U. Levy, J. Goren, A. Zafranski, and A. Savernin, "High power Li-Ion battery charger for electric vehicle," in *Proceeding of 2011 7th International Conference-Workshop Compatibility and Power Electronics (CPE)*, June 2011, pp. 342–347.
- [15] S. O. Yong and N. A. Rahim, "Development of on-off duty cycle control with zero computational algorithm for CC-CV Li ion battery charger," in *Proceeding of 2013 IEEE Conference on Clean Energy and Technology (CEAT)*, November 2013, pp. 422–426.
- [16] C.-C. Hua, H.-R. Chen, and Y.-H. Fang, "Inductive power transmission technology for Li-ion battery charger," in *Proceeding of 2013 IEEE 10th International Conference on Power Electronics and Drive Systems (PEDS)*, 2013, pp. 788–792.
- [17] K. Park, Y. Choi, S. Choi, and R. Kim, "Design consideration of CC-CV controller of LLC resonant converter for Li-ion battery charger," in *Proceeding of 2015 IEEE 2nd International Future Energy Electronics Conference (IFEEEC)*, 2015, pp. 1–6.
- [18] R. Kushwaha and B. Singh, "An EV battery charger based on PFC Sheppard Taylor Converter," in *Proceeding of 2016 National Power Systems Conference (NPSC)*, February 2017, pp. 1–6.
- [19] Vicor Corporation, "Design Guide & Applications Manual for Maxi, Mini, Micro Family DC-DC Converter and Accessory Modules," 2014.
- [20] Vicor Corporation, "Constant Current Control for DC-DC Converters," 2010.
- [21] Vicor Corporation, "72V Micro Family," 2017.

This page is intentionally left blank